



FP502

N-Channel Silicon MOSFET
Silicon Schottky Barrier Diode

DC-DC Converter Applications

Features

- Composite type with a high-speed N-channel MOSFET and a low-forward voltage Schottky barrier diode contained in the PCP4 package, saving the mount space greatly.

Package Dimensions

unit:mm

2132

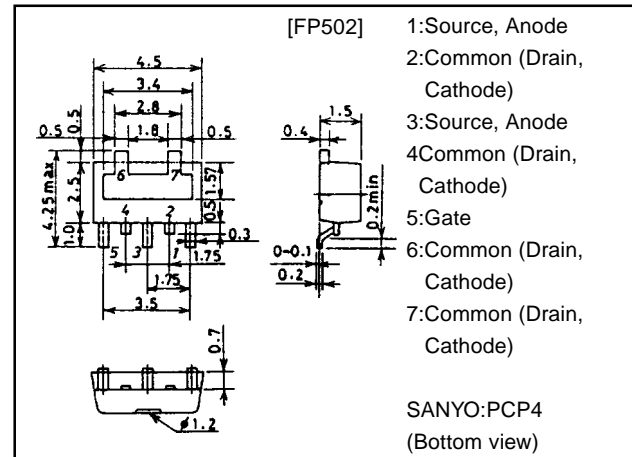

Specifications

Absolute Maximum Ratings at Ta = 25°C

Parameter	Symbol	Conditions	Ratings	Unit
Allowable Power Dissipation	P _D	T _c =25°C, 1 unit	3.5	W
	P _D	Mounted on ceramic board (250mm ² ×0.8mm) 1 unit	1.5	W
Storage Temperature	T _{stg}		-55 to +150	°C
[MOS block]				
Drain-to-Source Voltage	V _{DSS}		11	V
Gate-to-Source Voltage	V _{GSS}		±10	V
Drain Current (DC)	I _D		2	A
Drain Current (Pulse)	I _{DP}	PW≤10μs, duty cycle ≤1%	8	A
Channel Temperature	T _{ch}		150	°C
[Diode block]				
Average Rectified Current	I _O		500	mA

Electrical Characteristics at Ta=25°C

Parameter	Symbol	Conditions	Ratings			Unit
			min	typ	max	
[MOS block]						
D-S Breakdown Voltage	V _{(BR)DSS}	I _D =1mA, V _{GS} =0	11			V
Zero-Gate Voltage Drain Current	I _{DSS}	V _{DS} =10.4V, V _{GS} =0			400	μA
Gate-to-Source Leakage Current	I _{GSS}	V _{GS} =±8V, V _{DS} =0			±10	μA
Cutoff Voltage	V _{GS(off)}	V _{DS} =10V, I _D =1mA	1.0		4.0	V
Forward Transfer Admittance	Y _{fs}	V _{DS} =10V, I _D =1A	1.2	2.2		S
Static Drain-to-Source ON-State Resistance	R _{DS(on)}	I _D =1A, V _{GS} =10V		140	200	mΩ
	R _{DS(on)}	I _D =500mA, V _{GS} =4V		200	320	mΩ
Input Capacitance	C _{iss}	V _{DS} =10V, f=1MHz		150		pF
Output Capacitance	C _{oss}	V _{DS} =10V, f=1MHz		200		pF
Reverse Transfer Capacitance	C _{rss}	V _{DS} =10V, f=1MHz		45		pF

Continued on next page.

FP502

Continued from preceding page.

Parameter	Symbol	Conditions	Ratings			Unit
			min	typ	max	
[MOS block]						
Turn-ON Delay Time	$t_{d(on)}$	See specified Test Circuit.		10		ns
Rise Time	t_r	See specified Test Circuit.		25		ns
Turn-OFF Delay Time	$t_{d(off)}$	See specified Test Circuit.		25		ns
Fall Time	t_f	See specified Test Circuit.		20		ns
[Diode block]						
Forward Voltage	V_F	$I_F=500mA$		0.4	0.45	V
Reverse Recovery Time	t_{rr}	$I_F=500mA, di/dt=50A/\mu s$		20	30	ns

Switching Time Test Circuit

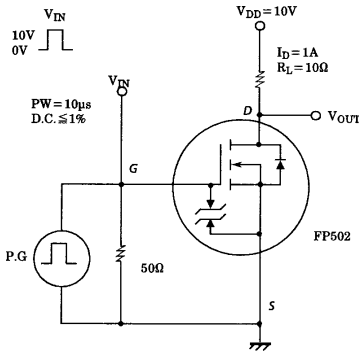

Electrical Connection

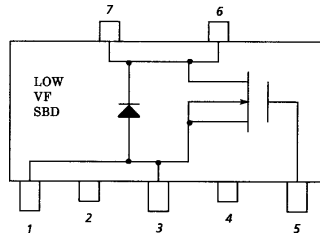

- 1:Source, Anode
- 2:Common (Drain, Cathode)
- 3:Source, Anode
- 4:Common (Drain, Cathode)
- 5:Gate
- 6:Common (Drain, Cathode)
- 7:Common (Drain, Cathode)

(Top view)

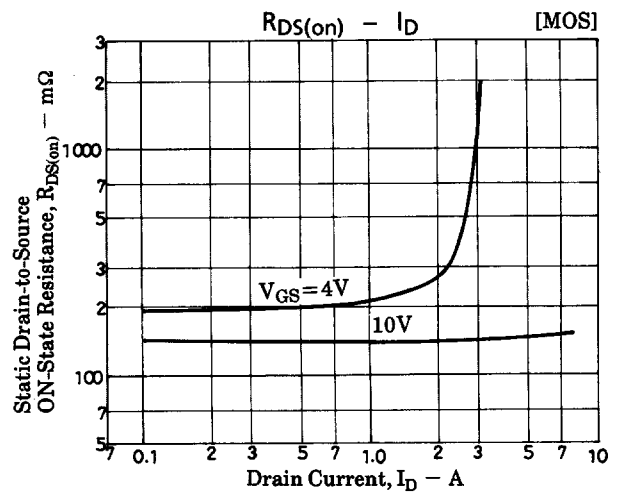
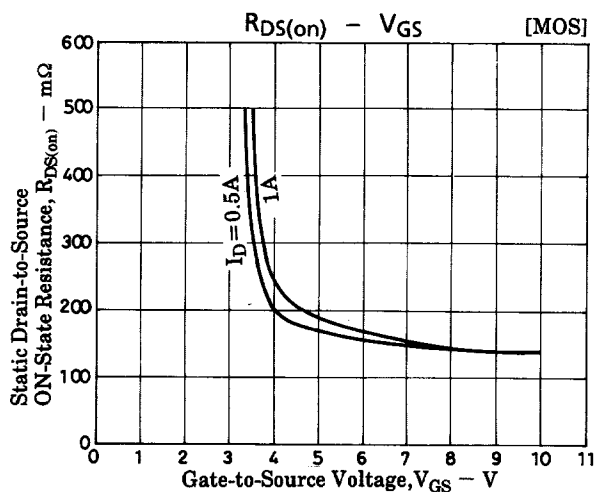
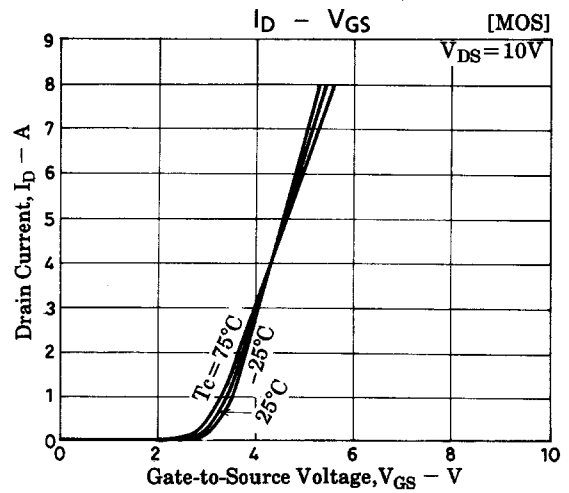
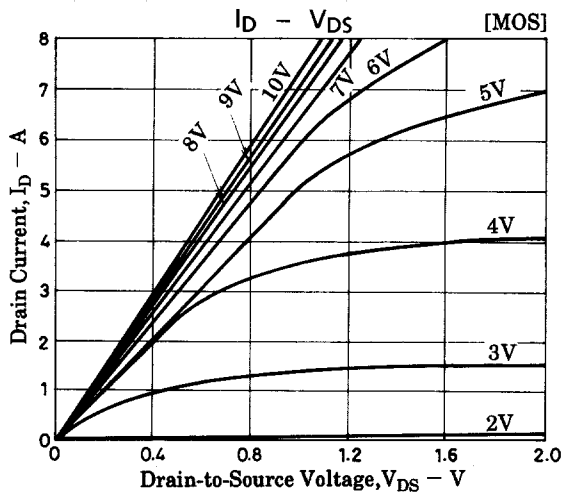

FP502

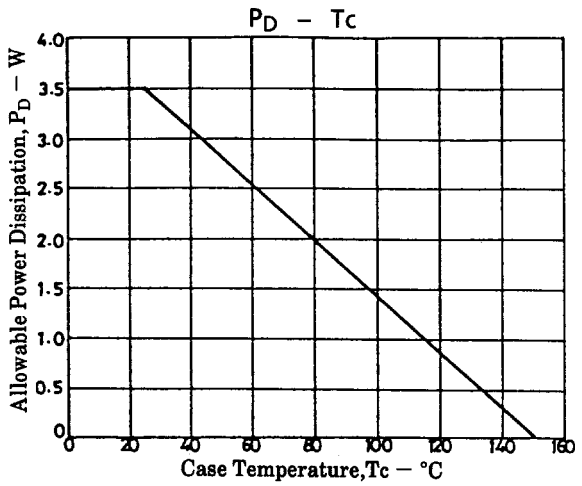
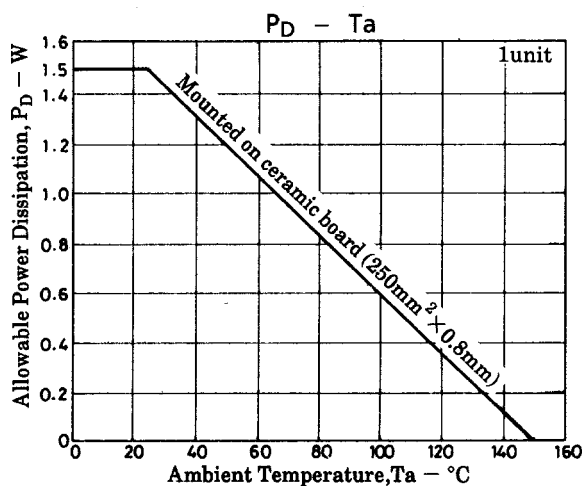
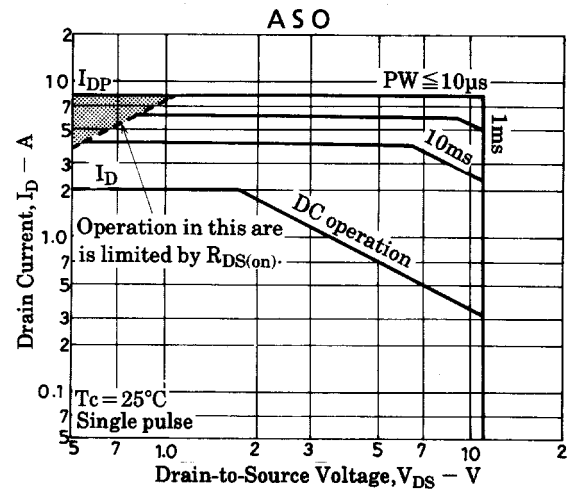
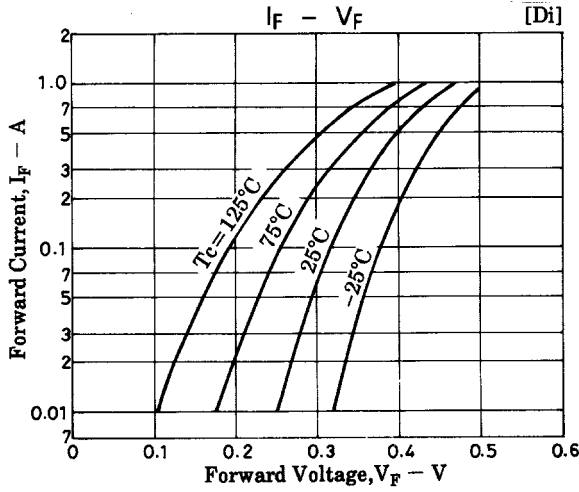
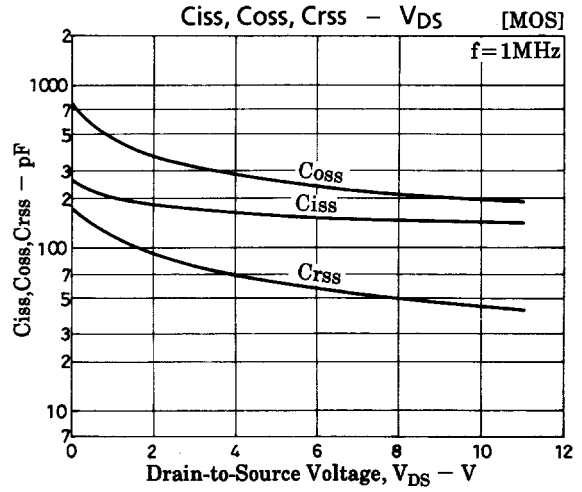
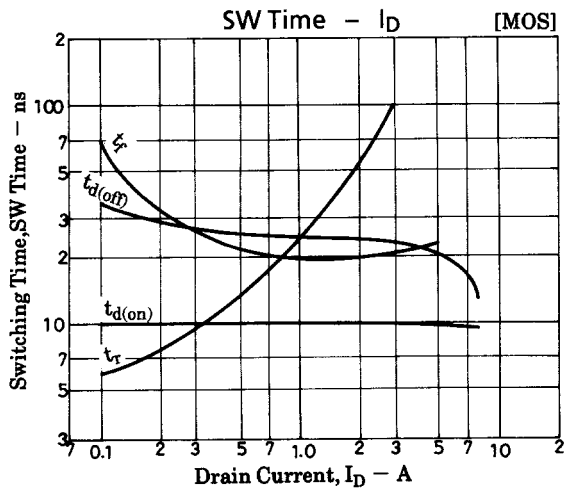
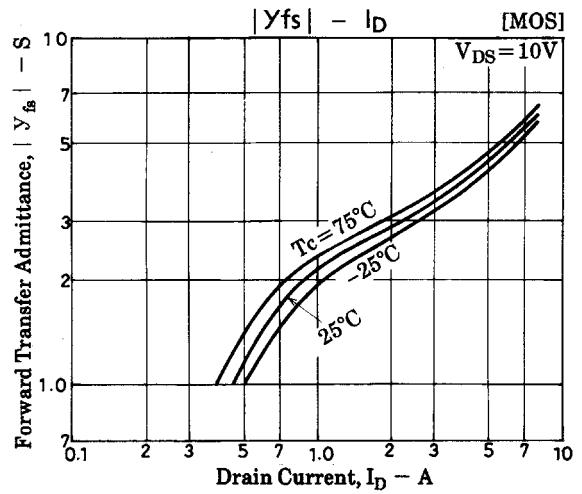
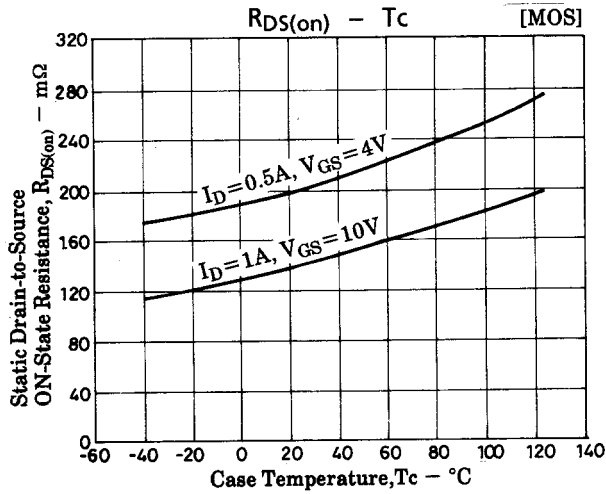

- No products described or contained herein are intended for use in surgical implants, life-support systems, aerospace equipment, nuclear power control systems, vehicles, disaster/crime-prevention equipment and the like, the failure of which may directly or indirectly cause injury, death or property loss.
- Anyone purchasing any products described or contained herein for an above-mentioned use shall:
 - ① Accept full responsibility and indemnify and defend SANYO ELECTRIC CO., LTD., its affiliates, subsidiaries and distributors and all their officers and employees, jointly and severally, against any and all claims and litigation and all damages, cost and expenses associated with such use:
 - ② Not impose any responsibility for any fault or negligence which may be cited in any such claim or litigation on SANYO ELECTRIC CO., LTD., its affiliates, subsidiaries and distributors or any of their officers and employees jointly or severally.
- Information (including circuit diagrams and circuit parameters) herein is for example only; it is not guaranteed for volume production. SANYO believes information herein is accurate and reliable, but no guarantees are made or implied regarding its use or any infringements of intellectual property rights or other rights of third parties.

This catalog provides information as of May, 1998. Specifications and information herein are subject to change without notice.